

# PÀSSIONE B E A U T Y

PREPARATION,  
APPLICATION ACRILGEL

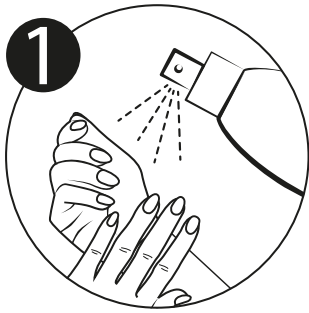

# Preparation without a nail drill



Spray **Fresh & Pure** onto hands and nails and allow to air dry.



Trim the free edge of the nail with a file.

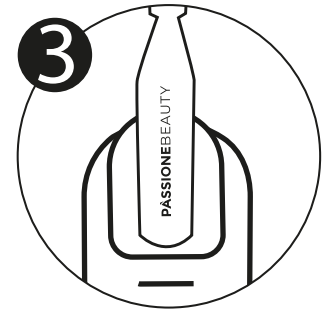

Gently push back the cuticles.

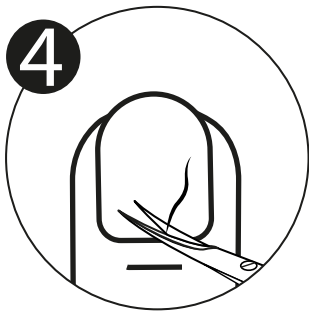

Remove cuticles with nail scissors.



Buff the surface of the natural nail using a **nail file**.



Use **Nail Brush** to remove all dust from the surface.

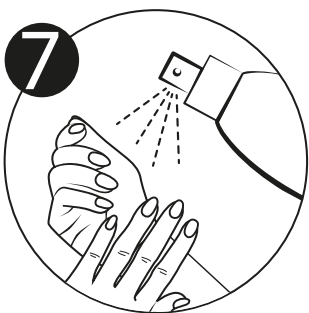

Spray **Fresh & Pure**.

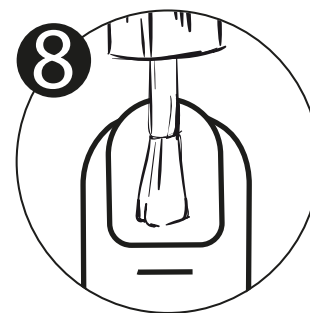

Appliquer les préparateurs sur toute la surface de l'ongle naturel dans l'ordre suivant: **Nail Prep** et **Binder**. En cas d'ongles difficiles, procéder à l'application du **Primer** après le **Nail Prep** et avant le **Binder**. Laisser sécher préparateurs à l'air libre.

**NOTE: APPLY BINDER AND PRIMER ONLY ON THE NATURAL NAIL, ALSO IN CASE OF AN INFILL**

# Preparation using a nail drill - Russian Manicure



Spray **Fresh & Pure** onto hands and nails and allow to air dry.

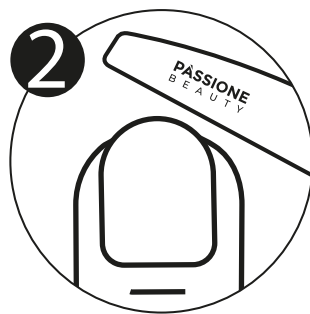

Trim the free edge of the nail with a file.

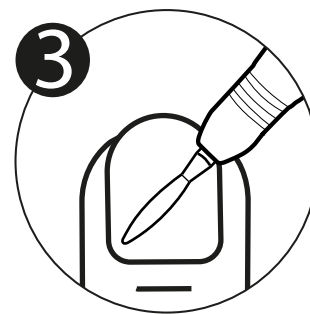

Use a flame-shaped diamond drill bit such as the **Dry Diamond Flame Nail Drill Bit Medium** to lift the cuticle from the nail bed.

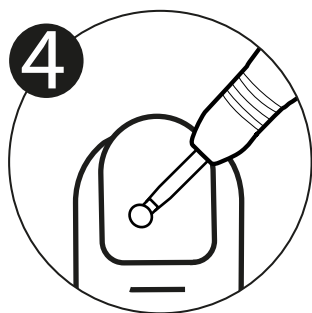

After that, use a round diamond drill bit such as the **Dry Diamond Ball Nail Drill Bit** to remove even the driest of cuticles without using nail scissors and to smooth down any thickening of the skin.

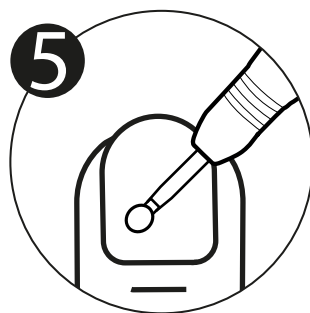

Go over the cuticle area to remove any residue, possibly using the **Ball Stone Nail Drill Bit** pumice stone tip.



Use **Nail Brush** to remove all dust from the surface.



Spray **Fresh & Pure**.

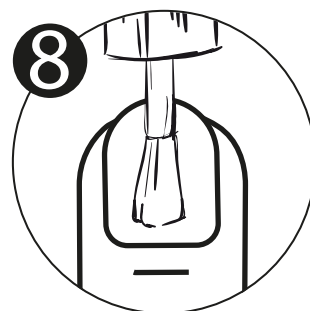

Apply the preparatory liquids over the entire surface of the natural nail in the following order: **Nail prep and Binder**. In the case of difficult nails proceed by adding the **Primer** after the **Nail prep and before the Binder**. Allow the preparatory liquids to air dry

**NOTE: APPLY BINDER AND PRIMER ONLY ON THE NATURAL NAIL, ALSO IN CASE OF AN INFILL.**

# Base application

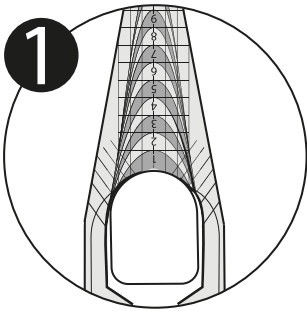

1 Cut out and position the **Nail Form** so that it matches the shape of the hyponychium leaving no gap between the two. Close the Nail Form according to the shape you want to create, matching the lower wings perfectly.

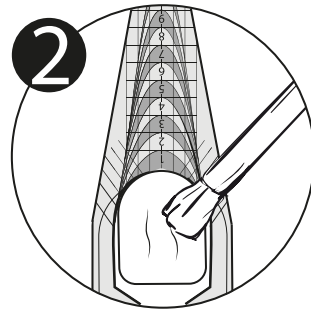

2 Apply a very thin, even layer of base coat suitable for the application of **Acrilgel** as indicated on the product sheet. Spread the product on the nail bed with a **Trendy Base brush** and make sure to apply the base between the natural nail and the nail form in order to secure it.

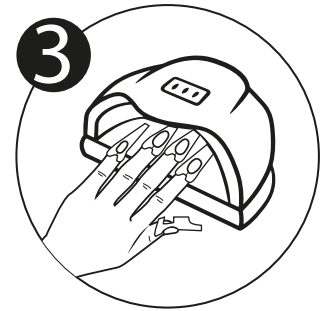

3 Cure the product for **30 seconds** under UV/Led lamp (Futura, SUNUV 5 PLUS or SUNUV 4S) or **120 seconds** under UV lamp.

# Acrilgel application with Nail Form

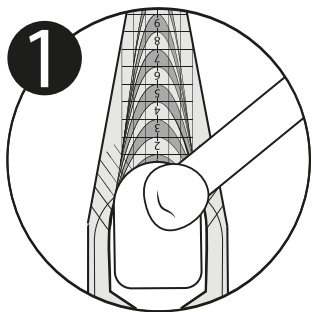

Pick up a bead of Acrilgel with a spatula and place it on the Nail Form.

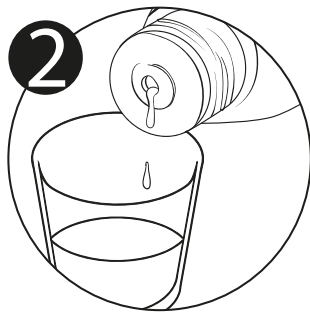

Pour a small amount of **AcrilGel Solution** into the dappen dish.

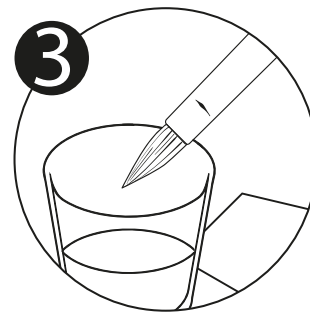

Dip the Acrilgel brush, such as **Kolinsky Brush 2** or **Brush Spatula**, into AcrilGel Solution and drain the excess on a Pad.

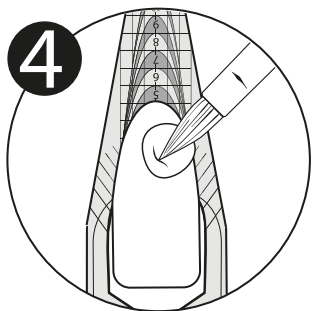

**Create the extension** shaping the pearl with the brush belly to the desired length.



**Cure** under UV/Led lamp according to the times indicated on the label and product sheet;

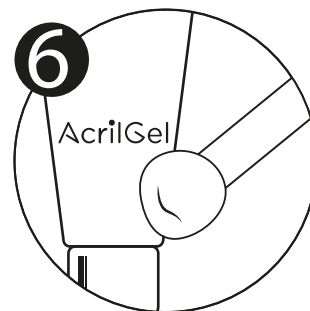

Take a larger bead of product than the previous one.

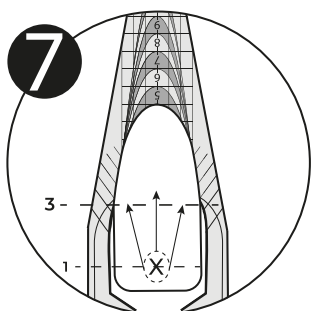

**Built the apex:** place the bead of product at 1/3 of the natural nail, shape it approaching the cuticles, then move the product towards the length, without pulling the apex of the nail.



**Cure** under UV/Led lamp according to the times indicated on the label and product sheet.

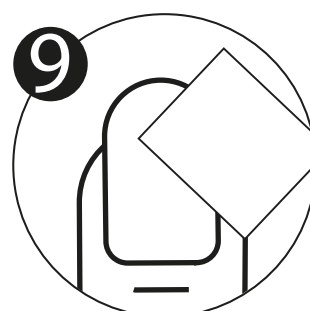

Vigorously remove the inhibition layer with the **Cleaner**.

# Acrilgel application with Nail Form

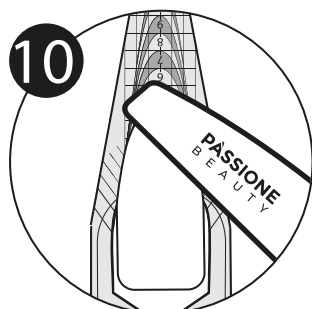

File the structure using a **precision file**. If you prefer to use a nail drill for filing, we recommend a conical, medium-abrasion tungsten carbide bit such as the **Carbide Refill Bit**.

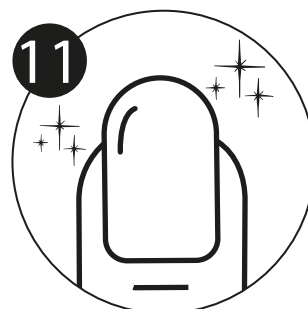

**Decorate** as desired with gel colour, gel polish or **seal**.

## WHAT NOT TO DO

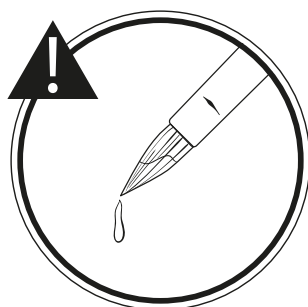

*Soak the brush too much into the Acrilgel Solution.*

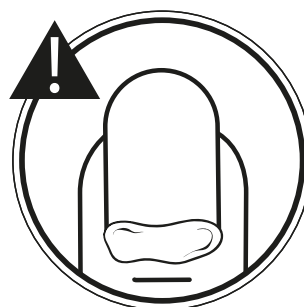

*Applying product on the cuticles.*

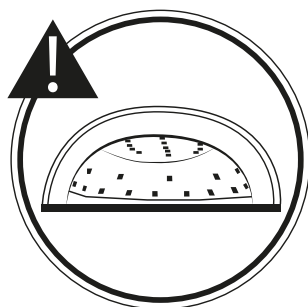

*Using a lamp with inadequate performance (e.g. minimum 30/36 diodes). we recommend Futura, SUNUV 5 PLUS or SUNUV 4S.*

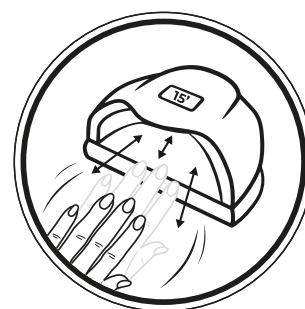

**NOTE:** *Acrilgel is a product that does not develop heat in lamp, however, if the customer is sensitive and feels a sensation of heat, move your hand in and out of the lamp 10 times during each curing process.*

# Acrigel application with Dual Form

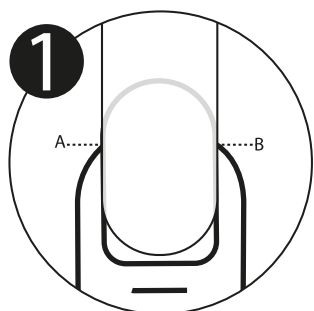

Choose the **Dual Form** of the appropriate size; the Dual Form should cover points A and B.

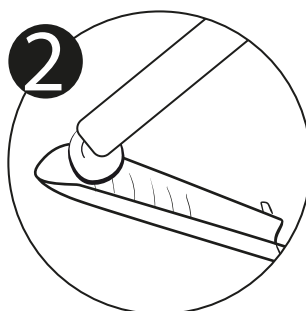

Pick up a bead of Acrigel with a spatula and place it on the Dual Form.

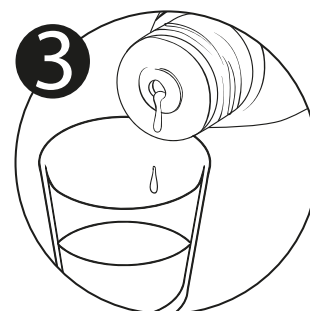

Pour a small amount of **Acril-Gel Solution** into the **dappen dish**.

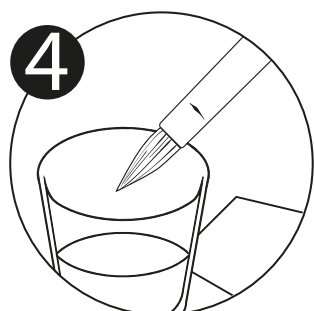

Dip the Acrigel brush, such as **Kolinsky Brush 2** or **Brush Spatula**, into AcrilGel Solution and drain the excess on a Pad.

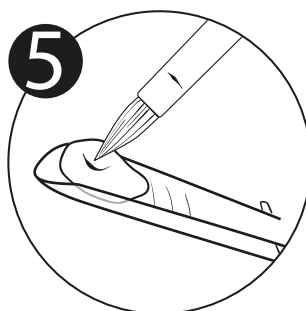

Model Acrigel on the **Dual Form**.

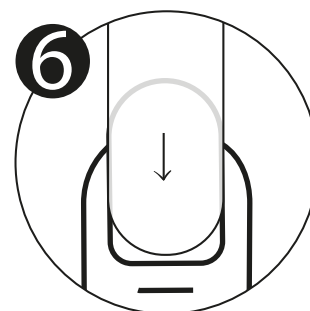

Place the Dual Form on the nail surface and **press lightly**.



To lock the position of the Dual Form cure for 10 seconds under a **UV/LED lamp**.

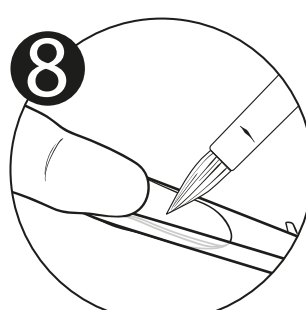

**Turn the hand over** and distribute the product evenly (in the extension).



Complete curing according to the times indicated on the label and product sheet.

# Acrilgel application with Dual Form

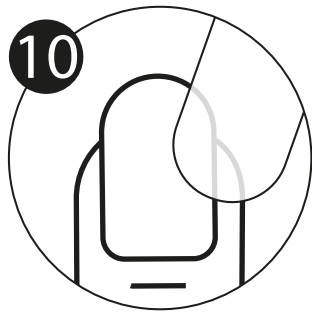

Remove **Dual Form**.

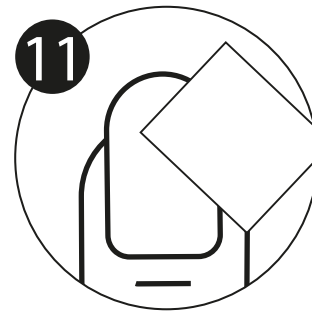

Vigorously remove the inhibition layer with the **Cleaner**.



File the structure using a **precision file**. If you prefer to use a nail drill for filing, we recommend a conical, medium-abrasion tungsten carbide bit such as the **Carbide Refill Bit**.

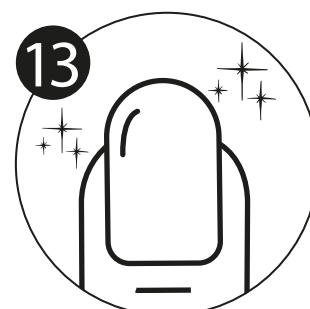

**Decorate** as desired with gel colour, gel polish or **seal**.



## WHAT NOT TO DO



*Soak the brush too much into the Acrilgel Solution.*

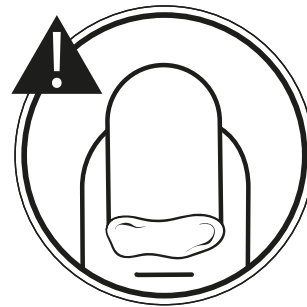

*Applying product on the cuticles.*

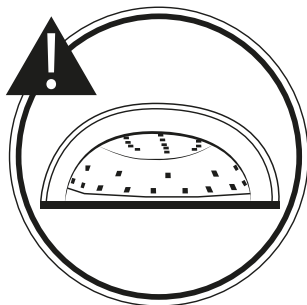

*Using a lamp with inadequate performance (e.g. minimum 30/36 diodes). we recommend Futura, SUNUV 5 PLUS or SUNUV 4S.*

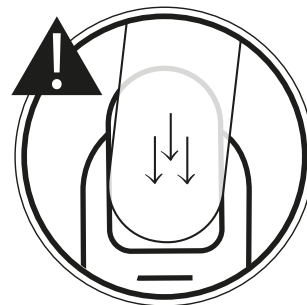

*Press the Dual Form down excessively: the Dual Form must be straight, i.e. on axis with the finger.*

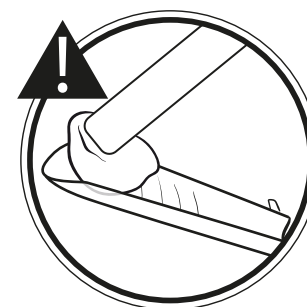

*Apply too much product on the Dual Form.*

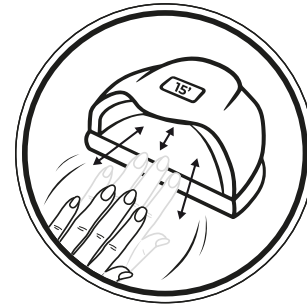

**NOTE:** *Acrilgel is a product that does not develop heat in lamp, however, if the customer is sensitive and feels a sensation of heat, move your hand in and out of the lamp 10 times during each curing process.*